

# Instructions for Aluminum Structural Post

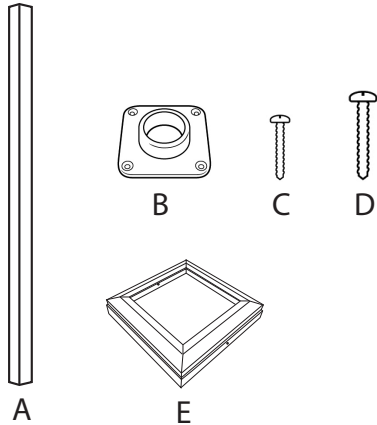

www.colorguardrailings.com



## Component List:

- A) Aluminum Post - 1
- B) Plates - 2
- C) #10 x 3/4" SS Screws - 4
- D) #10 x 1 3/4" SS Screws - 4 (painted head)
- E) Collar - 2

## Tools Required:

- Measuring tape
- Level
- Phillips screw driver bit
- Drill
- 1/4" Drill bit

*Installer is responsible for quality workmanship and meeting all building codes.*

**Note: Installer must provide appropriate flat head fasteners to attach the plates. This will differ depending on the type of surface. 8 are required, and may not be the same. The top and bottom plates may need different fastener types depending on surface.**

*Always wear safety goggles*

MADE IN THE USA

## 1 Measure & Cut Post

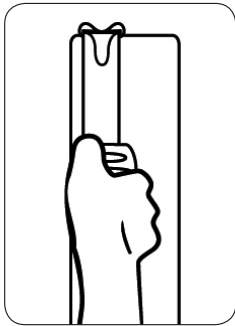

**ezTIP:** The unfolded box makes a clean work surface, keeping post clean and scratch free.

Measure and cut Structural Post using a fine tooth carbide saw blade 1/2" shorter than opening.

Insert collars and plates into each end of post. Upright post, and position in desired location.

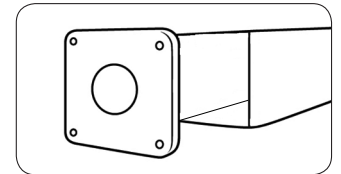

## 2 Position Post

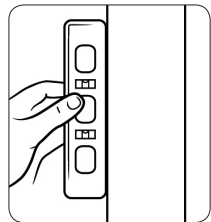

Place posts in desired location. Be sure to check front to back and left to right level (orientated square to mounting surface).

Mark plate edges on mounting surface. Rotate post to expose holes on the plate.

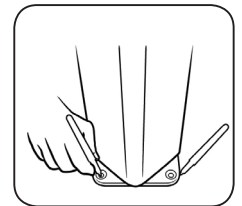

## 3 Attach Post to Bottom Surface

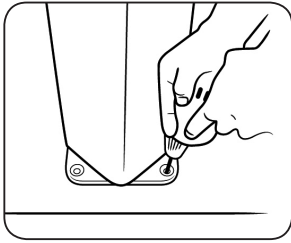

Pre-drill through bottom plate hole into bottom surface, secure (hardware not included, be sure to allow for countersink), and repeat with remaining 3 holes.

**Note:** Consult building products supplier for proper mounting hardware as well as information on hole diameter to drill in order to meet building codes and application conditions. **Fasteners must be flat head.**

**ezTIP:** Hold drill carefully so drill chuck does not rub on Structural Post while drilling holes. If necessary, place cardboard between drill and post to protect finish on Structural Post.

## 4 Attach Post to Top Surface

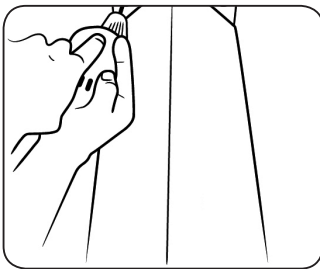

Repeat steps 2 and 3 for top of post using appropriate, installer provided fasteners, also must allow for countersink, and adjust the hole size from step 3 accordingly. Rotate post back to square with bottom plate.

**Note:** Consult building products supplier for proper mounting hardware as well as information on hole diameter to drill in order to meet building codes and application conditions.

## 5 Attach Post to Plate

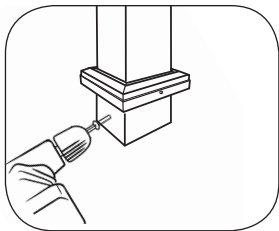

**ezTIP:** Drill bit size is important. Using a  $\frac{1}{64}$ " bit ensures proper installation and prevents screw from breaking.

Drill  $\frac{1}{64}$ " holes  $\frac{5}{8}$ " up from bottom of post on center of side opposite of collar mounting holes. Drill through post and mounting plate.

Install (1) #10 x  $\frac{3}{8}$ " stainless steel screw and secure. Repeat for opposite side. Repeat process for top of post. Do not over tighten screws; post should not appear to be concave.

## 6 Attach Collar

Drill  $\frac{1}{64}$ " holes through collar, post and mounting plate. Install #10 x  $1\text{-}\frac{3}{4}$ " painted head screws. Do not over tighten.

## 7 Finish Installation

1. Clean post with soft cloth and mild non-abrasive household cleaner.
2. Snap on top and bottom post collars into place, if applicable. Secure with silicone, not provided. *Collars are sold separately, see your Color Guard dealer.*