

Instructions for Structural Posts

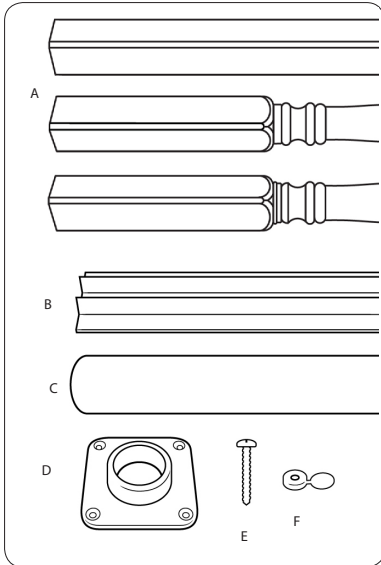

www.colorguardrailing.com



Component List:

- A) Vinyl Post (3 options) - 1
- B) Filler Block - 8
- C) Structural Aluminum Post - 1
- D) Plates - 2
- E) #10 x 1³/₄" S S Screws - 8
- F) Button Covers - 8

Fasteners Installer provided - 8

Installer is responsible for quality workmanship and meeting all building codes

Note: Installer must provide appropriate flat head fasteners to attach the plates. This will differ depending on the type of surface. 8 are required, and may not be the same. The top and bottom plates may need different fastener types depending on surface.

Tools required:

- Measuring tape
- Silicone
- Level
- Phillips screw driver bit
- Drill
- 1¹/₆₄" Drill bit

Always wear safety goggles

MADE IN THE USA

1 Measure & Cut Post

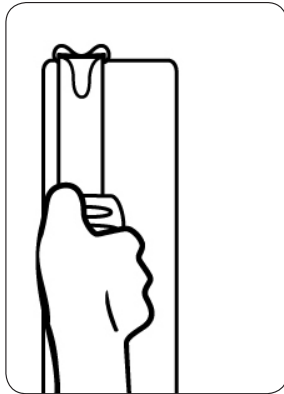

ezTIP: The unfolded box makes a clean work surface, keeping post clean and scratch free.

Measure and cut Vinyl Post, Structural Post and fillers using a fine tooth carbide saw blade 1/2" shorter than opening, keeping in mind proportions as well as rail attachment requirements, if applicable.

- 42" rail heights require cut from top of post only
- 36" rail heights allows you to cut up to 6" cut from bottom, and remainder from top of post.

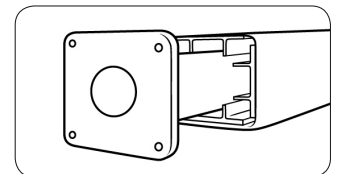

Insert plates into each end of post. Upright post,

2 Position Post

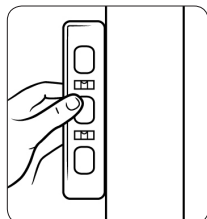

Place posts in desired location. Be sure to check front to back and left to right level (orientated square to mounting surface).

Mark plate edges on mounting surface. Rotate vinyl post 1/4 turn, exposing holes on the plate.

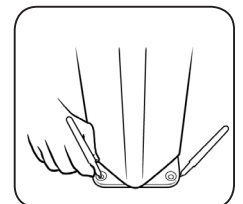

3 Attach Post to Bottom Surface

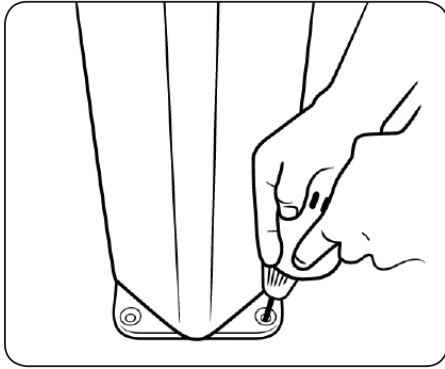

Pre-drill through bottom plate hole into bottom surface, secure (hardware not included, be sure to allow for countersink), and repeat with remaining 3 holes

Note: Consult building products supplier for proper mounting hardware as well as information on hole diameter to drill in order to meet building codes and application conditions. **Fasteners must be flat head.**

ezTIP: Hold drill carefully so drill chuck does not rub on Structural Post while drilling holes. If necessary, place cardboard between drill and post to protect finish on Structural Post.

4 Attach Post to Top Surface

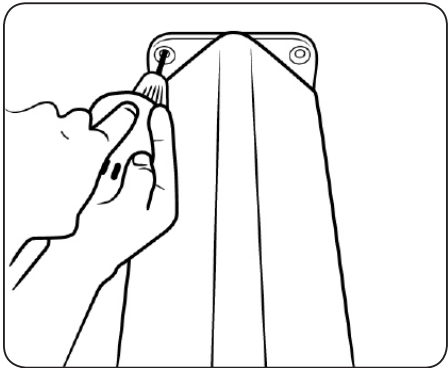

Repeat steps 2 and 3 for top of post using appropriate, installer provided fasteners, also must allow for countersink, and adjust the hole size from step 3 accordingly. Rotate post back to square with bottom plate

Note: Consult building products supplier for proper mounting hardware as well as information on hole diameter to drill in order to meet building codes and application conditions.

5 Attach Post to Plate

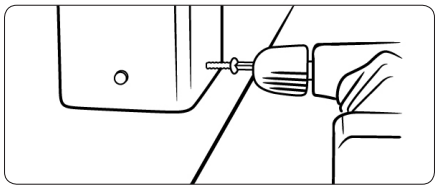

ezTIP: Drill bit size is important. Using a $\frac{1}{64}$ " bit ensures proper installation and prevents screw from breaking.

Drill $\frac{1}{64}$ " holes $\frac{5}{8}$ " up from bottom of post on center of side. Penetrate outside post, filler, aluminum structural post and mounting plate. *(This process ensures installation meets uplift code.)*

NOTE: When using optional collars, do not use button covers, the screws will be covered by the collars. The collars will not fit if the button covers are installed.

Place button covers on #10 x 1-3/4" Stainless Steel screw and secure. Repeat for remaining 3 sides. Repeat process for top of post. Do not over tighten screws; post should not appear to be concave. Snap button covers, not shown, over screws.

6 Finish Installation

1. Clean Post with soft cloth and mild non-abrasive household cleaner.
2. Snap on top and bottom post collars into place, if applicable. Secure with silicone, not provided. *Collars are sold separately, see your Color Guard dealer.*